

Montage- & Gebrauchsanleitung Planierflieger PFL

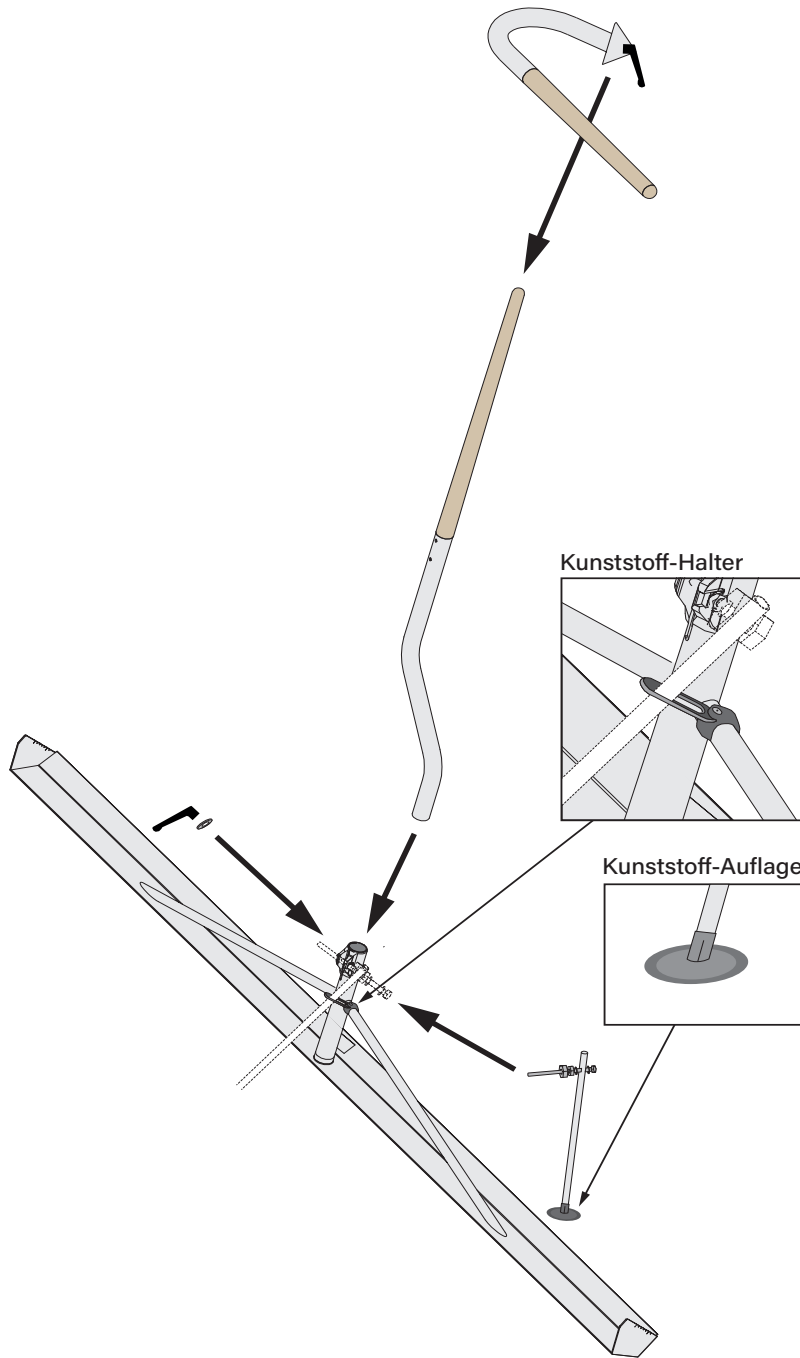

Körpergröße 1:

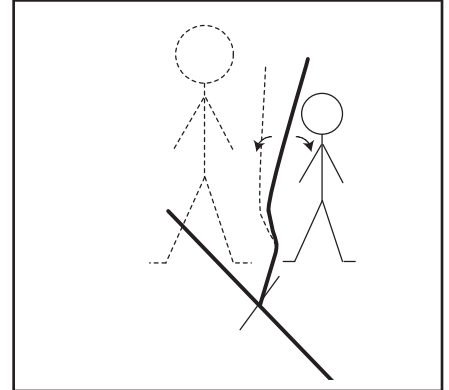

Körpergröße 2:

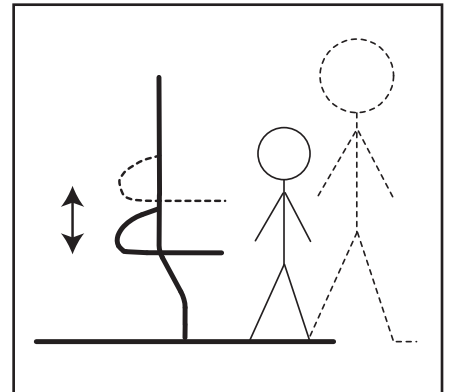

Linkshänder (L):

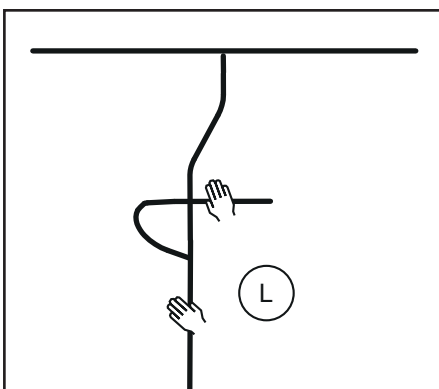

Rechtshänder (R):

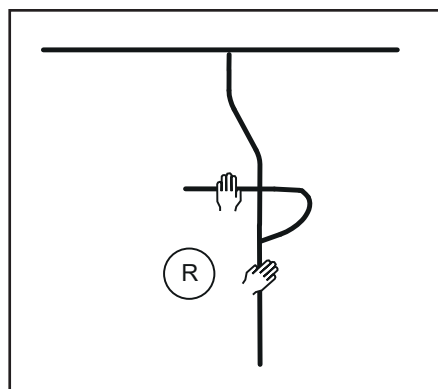

Montage-Video

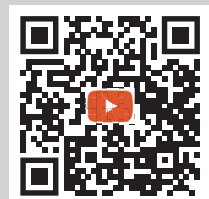

Gezogene Materialmenge resultiert aus der Neigung des Gerätes (Schneidkante)

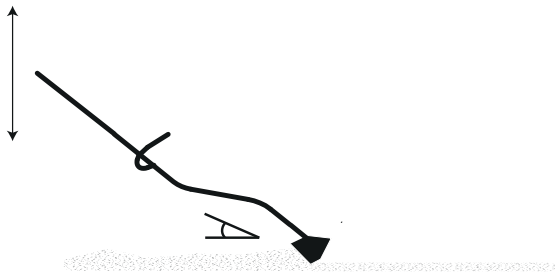

Standposition:



Bei Bedarf nachgreifen:

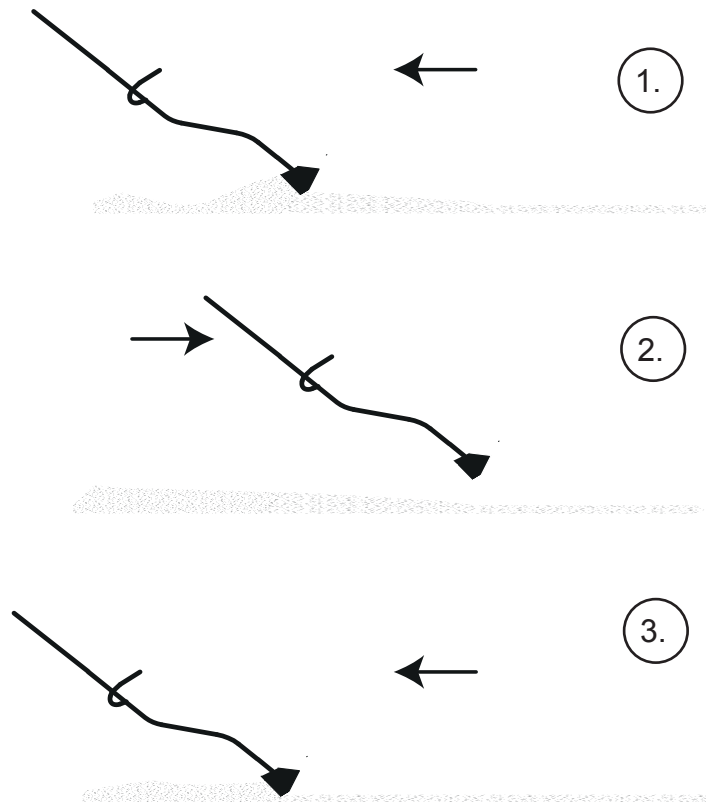

Handposition mehr Material rechts:

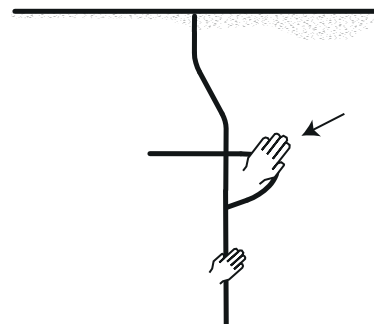

Handposition mehr Material links:

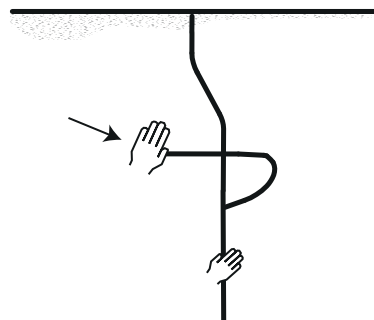

Seitliche Höhenabnahme mit Aufsetzrolle

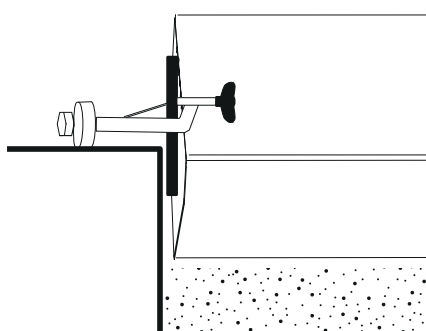

Einstellung der Abziehhöhe an Unterkante der Aufsetzrolle

